

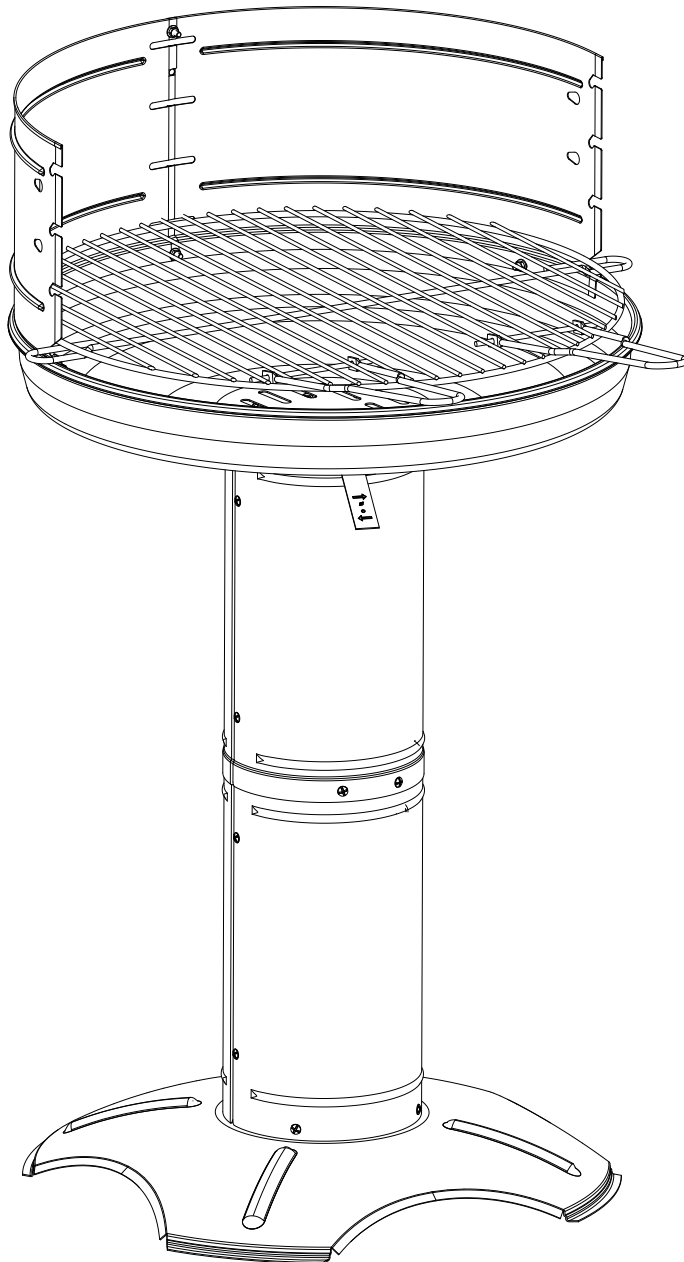

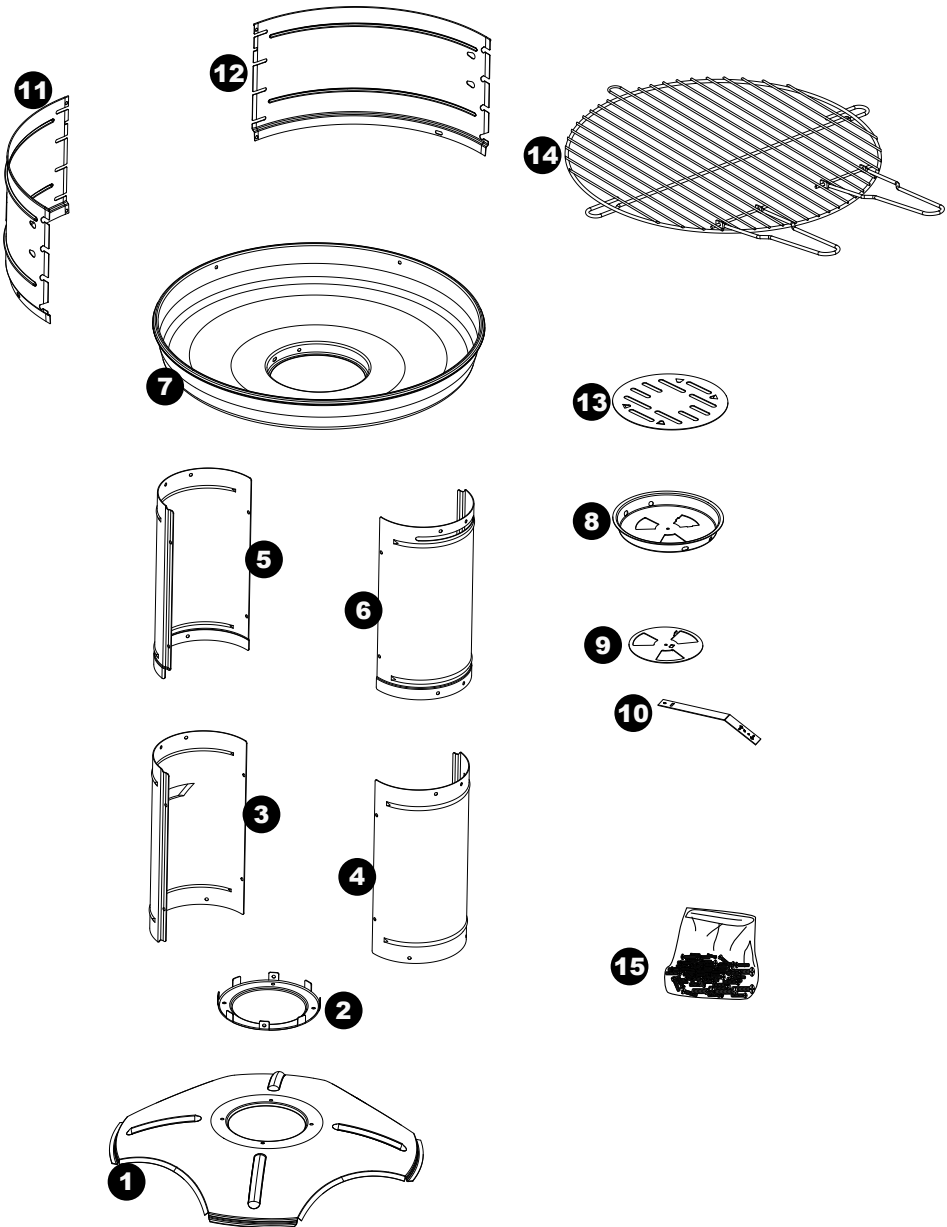

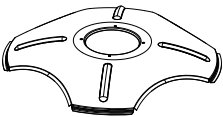





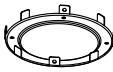
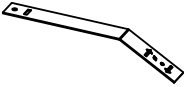
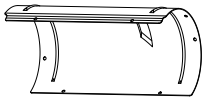

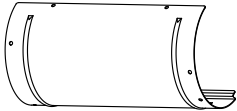

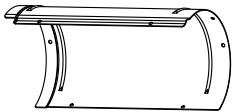

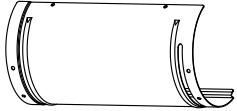

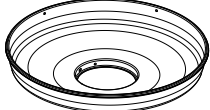

# TOM 300601i NF





<b>1</b>		x 1	<b>9</b>		x 1
<b>2</b>		x 1	<b>10</b>		x 1
<b>3</b>		x 1	<b>11</b>		x 1
<b>4</b>		x 1	<b>12</b>		x 1
<b>5</b>		x 1	<b>13</b>		x 1
<b>6</b>		x 1	<b>14</b>		x 1
<b>7</b>		x 1	<b>15</b>		x 1
<b>8</b>		x 1			

	5 x 12	4
	4 x 16	4
	4 x 12	20
	4 x 8	1
	Ø 5	4
	Ø 4	25
	Ø 5	4
	Ø 4	25



APPAREILS MÉNAGERS  
UTILISANT DES COMBUSTIBLES  
LIQUIDES OU SOLIDES

[www.marque-nf.com](http://www.marque-nf.com)



DOMESTIC APPLIANCES  
USING LIQUID OR SOLID FUELS

[www.marque-nf.com](http://www.marque-nf.com)

